



BPC Building Products Ltd

POWAPost Landscaping

Part of the Vista Group

bpc[®]



In today's market you need a brand you can turn to for proven products, reliable support and competitive prices.

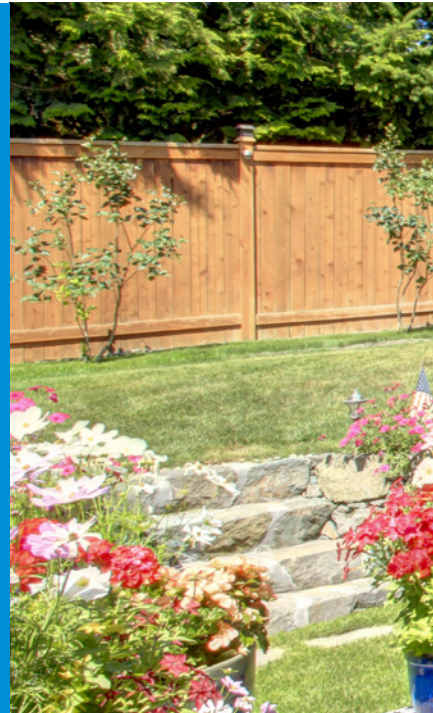

Welcome to BPC

Formed in 1977, BPC is an established UK manufacturer of galvanised and stainless steel building components. We offer a quality product range at competitive prices and service that is second to none.

Part of the Vista group

The Vista Group is the U.K.'s largest independent manufacturer of builders' metalwork. Created in 2018 by the merger of Vista Engineering, BPC Fixings and GA Fixings, our brands share common values of customer focus, proven products and competitive prices.

We are committed to the continuous development of our products, people and processes. Our products and UK facilities are certified to the very highest levels so you can be confident you're choosing the very best for your building project.

- ✓ BPC IS AN ISO 9001:2015 COMPANY CERTIFICATE NO. 18663-QMS-001
- ✓ BS EN 10346:2015 PRE-GALVANISED STEEL
- ✓ BS EN 10088-2 STAINLESS STEEL





Proven products

Our landscaping range is just part of a much broader choice of high-quality Vista Group products, engineered to meet the demanding specifications of today's construction industry. For over 40 years, we've been exploring new manufacturing methods and improving existing ones to provide a superior product to our customers and meet their needs more effectively.

And by investing in staff, machinery and premises at our 4 UK sites, we're able to increase efficiency and drive down costs while maintaining the highest possible standards. Our ISO 9001 certification is your guarantee of quality in our manufacturing process, from the high grade steel that enters our factory to the high performance finished products – many of them carrying BBA approval – that leave it.

Reliable support

Strong, supportive relationships have always been at the heart of our business. It's how we develop a clear understanding of what our customers need and how we work closely with them to deliver their requirements. Our friendly, knowledgeable Customer Service Team are there to deal with your enquiries and make sure you get the products you want, when and where you need them.

With a large stock-holding facility and a rapid, reliable delivery network, we can provide mixed loads of products wherever they're needed at a moment's notice. We also provide a full technical design service for products such as windposts and masonry support where it's required.

Competitive prices

Being more efficient in our approach to product design, manufacturing, service, packaging and distribution means we can be more competitive with our prices. That's because we pass on the benefits that come from economies of scale and more efficient operations in every area of our business. All with the aim of giving our merchant customers better margins and healthier profits and providing builders and contractors with even better value for money.

Contents

4	PowaPost® Fencing Products
10	Decking Products
12	Miscellaneous Brackets
13	PowaRack™ Storage Solutions
14	PowaPost® Cube
15	PowaPost® Gates



PowaPost® Fencing Products

Designed to make the erection of fencing, gazebos, pergolas and other garden structures quick and easy, the PowaPost® range of fence post spikes offer strong anchorage for timber posts and are manufactured from welded heavy duty mild steel, powder coated after fabrication.

POWAPOST®



DPS

Drive-In Fence Post Spike

Benefits of using PowaPost® Post Supports

- PowaPost® is cost effective – uses shorter posts and no concrete required.
- PowaPost® saves time and effort – no digging and quick, easy installation.
- PowaPost® design – protects timber from water, fungal and insect damage.
- Powder coated.

Installation

Suitable for most ground conditions, simply drive the spike into the ground using the PowaPost® driving tool. The four fin spike is designed for easy insertion with minimal twisting, and secure anchorage into the ground.

The Twin Bolt arrangement mechanically tightens around the post allowing easy removal of damaged or rotten posts.

Code	Size	Spike Length	Pack Qty.
DPS/50/600*	50 x 50mm	450mm	8
DPS/75/600*	75 x 75mm	450mm	8
DPS/75/750*	75 x 75mm	600mm	8
DPS/100/750*	100 x 100mm	600mm	8

* Product code refers to overall length of component, i.e. 450mm spike plus 150mm shoe = 600 code.



G/DPS
Galvanised Drive-In Fence Post Spike



The Twin Bolt arrangement mechanically tightens around the post allowing easy removal of damaged or rotten posts.

- Hot dip galvanised after fabrication for superior corrosion resistance.
- Ideally suited to coastal areas.

Installation

Suitable for most ground conditions, simply drive the spike into the ground using the PowaPost® driving tool. The four fin spike is designed for easy insertion with minimal twisting, and secure anchorage into the ground.

Code	Size	Spike Length	Pack Qty.
G/DPS/75/2PK	75 x 75mm	600	2 PK
G/DPS/100/2PK	100 x 100mm	600	2 PK



Also available in
RETAIL PACKS OF 2

POWAPOST



EASYDPS
EasyGrip Drive-In Post Spike

The EasyGrip design holds the timber post in a tight wedge grip without the need for fixings.

Installation

Suitable for most ground conditions, simply drive the spike into the ground using the PowaPost® driving tool. The four fin spike is designed for easy insertion with minimal twisting, and secure anchorage into the ground.

Code	Size	Spike Length	Pack Qty.
EASYDPS/50/600	50 x 50mm	450mm	8
EASYDPS/75/750	75 x 75mm	600mm	8
EASYDPS/100/750	100 x 100mm	600mm	8



POWAPOST



DT
Driving in Tool

This robust universal tool is designed to aid installation of Post Spikes, to protect the shoe whilst hammering into the ground. The PowaPost® Driving Tool should always be used when installing Post Spikes.

Code	Size	Box Qty.
DT/50	50 x 50mm	20
DT/75	75 x 75mm	20

DT/75 is also suitable for 100 x 100mm spikes



POWAPOST





POWApost



PS1 Bolt Down Post Shoe

The PowaPost® Bolt Down Shoe is designed for use when posts are required to be installed on an existing hard surface such as a concrete or wooden base. Ideal for use when building carports, pergolas, fencing and decking.

Code	Post Size	Pack Qty.
PS1/50	50 x 50mm	6
PS1/60	60 x 60mm	6
PS1/75	75 x 75mm	6
PS1/90	90 x 90mm	6
PS1/100	100 x 100mm	6



POWApost

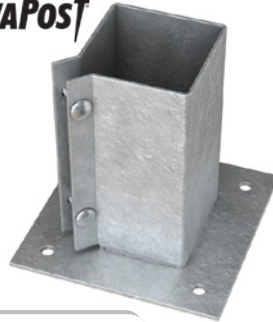

Also available in
RETAIL PACKS OF 2

G/PS1 Galvanised Bolt Down Post Shoe



The PowaPost® Bolt Down Shoe is designed for use when posts are required to be installed on an existing hard surface such as a concrete or wooden base. Hot dip galvanised after fabrication for superior corrosion resistance. Ideally suited to coastal areas.

Code	Post Size	Pack Qty.
G/PS1/75/2PK	75 x 75mm	2 PK
G/PS1/100/2PK	100 x 100mm	2 PK



POWApost



FPS1 Flush Fit Bolt Down Shoe

The Flush Fit Bolt Down is particularly suitable for applications where a post requires fitting against a flush surface or mounted on top of an existing wall, or in line with the edge of a patio or timberdeck.

Code	Post Size	Pack Qty.
FPS1/50	50 x 50mm	6
FPS1/75	75 x 75mm	6
FPS1/100	100 x 0mm	6



POWApost



EASYPS1 Bolt Down Post Shoe (EasyGrip)

The PowaPost® EasyGrip Bolt Down Shoe features a wedge type grip which allows quick and easy installation without the need for tightening bolts

Code	Post Size	Pack Qty.
EASYPS1/50	50 x 50mm	6
EASYPS1/75	75 x 75mm	6
EASYPS1/100	100 x 100mm	6
EASYPS1/150	150 x 150mm	6

PS2
Concrete-In Post Shoe

Designed for use when soil conditions are unsuitable for drive-in spikes.

Code	Post Size	Box Qty.
PS2/75	75 x 75mm	6
PS2/100	100 x 100mm	6



POWAPOST

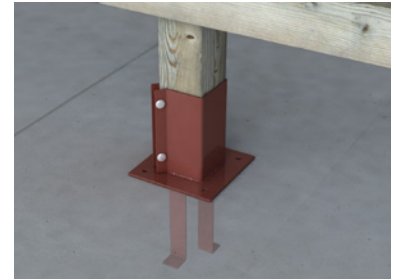

RS
Repair Spike

The PowaPost® repair spike is a sturdy welded shoe which provides an easy solution to broken or rotted timber posts that have been previously set into concrete. Perfect for repairing storm damaged fencing, the repair spike is installed quickly, eliminating the need to remove the existing concrete and without the need for digging or additional concreting.

Code	Post Size	Pack Qty.
RS/75	75 x 75mm	6
RS/100	100 x 100mm	6



POWAPOST

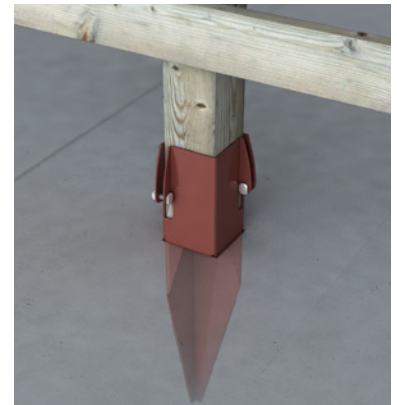

PEX
Post Extender

The PowaPost® Post Extender is a single piece welded box section 180mm long that enables easy extension of any 75 or 100mm timber post, allowing easy addition of decorative panels and trellis.

Code	Post Size	Pack Qty.
PEX/75	75 x 75mm	6
PEX/100	100 x 100mm	6



POWAPOST



PEB
Post Extender Bracket

Galvanised bracket (70 x 70 x 180mm long) used to extend timber posts. Use 2 brackets to extend 70 x 70mm to 150 x 150mm timber. Use 4 brackets for anything larger.

Code	Pack Qty.
PEB180	50



POWAPOST



PS3
Post Support

Heavy duty welded bracket (75 x 75mm with 220mm stem), designed to be set into concrete. To secure garden sleepers, posts for gazebos, carports and shelters. Not suitable for fencing.

Code	Timber Size	Pack Qty.
PS3/75	75 x 75mm	12



POWAPOST



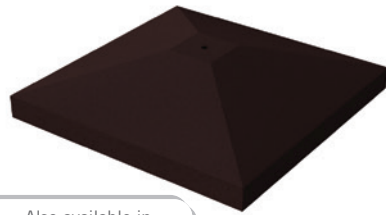

Also available in
RETAIL PACKS OF 10

PPC Plastic Post Caps

A decorative and functional cap that protects fence or deck posts from weather damage. (10 x 10 Poly bags)

Code	Post Size	Pack Qty.
PPC/75/10PK	For 75 x 75mm posts	10 x 10 PK



Also available in
RETAIL PACKS OF 4

PC1 Metal Post Cap Pyramid

NEW

A pyramid shape decorative and functional cap that protects fence or deck posts from weather damage. Available in brown and silver.

Code	Post Size	Pack Qty.
PC1B/75/4PK	75 x 75mm	10 x 4 PK
PC1B/100/4PK	100 x 100mm	10 x 4 PK
PC1S/75/4PK	75 x 75mm	10 x 4 PK
PC1S/100/4PK	100 x 100mm	10 x 4 PK



Also available in
RETAIL PACKS OF 2

PC2 Metal Post Cap Round

NEW

A round shape decorative and functional cap that protects fence or deck posts from weather damage. Available in brown and silver.

Code	Post Size	Pack Qty.
PC2B/75/2PK	75 x 75mm	10 x 2 PK
PC2B/100/2PK	100 x 100mm	10 x 2 PK
PC2S/75/2PK	75 x 75mm	10 x 2 PK
PC2S/100/2PK	100 x 100mm	10 x 2 PK



Also available in
RETAIL PACKS OF 8

ARB Aris Rail Brackets

For use with feather edge fencing, this galvanised bracket secures aris rails to posts. The ARB 285 has a pointed end.

Code	Size	Box Qty.
ARB/100	100mm	100
ARB/225	225mm	100
ARB/285	285mm	100
ARB/300	300mm	100

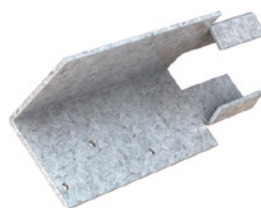

Also available in
RETAIL PACKS OF 4

MARB Mortice Aris Rail Bracket

Used to fix aris rails between concrete posts. Designed to be slotted into a mortice hole in concrete fence posts and nailed or screwed to timber aris rail.

Code	Box Qty.
MARB	50

CB
Corner Bracket Kit

A retail box containing 4 sturdy hot dipped galvanised brackets and all necessary fixings. Use these for creating raised beds with timber boards of any thickness or for strengthening corners in general timber construction.

Code	Size	Box Qty.
CB/200	60 x 60 x 200mm	20 Kits



Also available in
RETAIL KITS



PC
Panel Clip

A galvanised fixing used to securely attach fence panels to posts reducing the risk of nail damage to timber.

Code	Size	Box Qty.
PC/32	32mm	100
PC/38	38mm	100
PC/44	44mm	100
PC/50	50mm	100



Also available in
RETAIL PACKS OF 16



KRB
Knee Rail Bracket

A galvanised fixing used to securely attach knee rails to posts reducing the risk of nail damage to timber. Supplied once bent.

Code	Size	Box Qty.
KRB/75	500 x 75mm	50
KRB/100	475 x 100mm	50

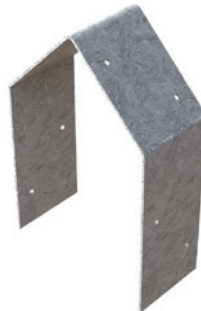

GBC
Gravel Board Clip

A galvanised bracket enabling secure fixing of gravel boards to fence posts.

Code	Size	Box Qty.
GBC/25x150	25 x 150mm	50
GBC/50x150	50 x 150mm	50
GBC/50x225	50 x 225mm	50



Also available in
RETAIL PACKS OF 2



2PINCLEAT
Two Pin Cleat



A hot dip galvanised welded bracket used to secure concrete gravel boards to concrete fence posts.

Code	Size	Box Qty.
2PINCLEAT/2PK	Universal	50 x 2 PK



Also available in
RETAIL PACKS OF 2



Decking Products



PB1 Deck Post Base

A bolt down post shoe used for installing deck posts onto an existing concrete base

Code	Post Size	Box Qty.
PB1/100	100 x 100mm	10



PB2 Deck Post Base

A sturdy 3mm thick shoe designed to fix deck posts into new concrete.

Code	Post Size	Box Qty.
PB2/100	100 x 100mm	10



Also available in
RETAIL PACKS OF 100

DC Decking Clips

An invisible way to attach wooden decking to the deck joists. Simply attach as shown for a sure fit with no screws.

Code	Box Qty.
DC/100	10 x 100 PK



45 x 45mm



90 x 45mm



90 x 90mm



180mm Flat

DC/AB40 Angle Bracket (DUAL COATED)

Manufactured from galvanised 40x3mm mild steel, powder coated after fabrication for superior dual coated corrosion protection.

Code	Size	Box Qty.
DC/AB40/45X45	45 x 45mm	100
DC/AB40/90X45	90 x 45mm	100
DC/AB40/90X90	90 x 90mm	100
DC/AB40/180F	180mm Flat	100

DC/MTH
Joist Hanger (DUAL COATED)

Timber to timber joist hanger to support 47mm wide joists from 100 to 150mm in depth. Manufactured from 2mm thick galvanised steel, powder coated after fabrication for superior dual coated corrosion protection.

Code DC/MTH/240/47
Box Qty. 50

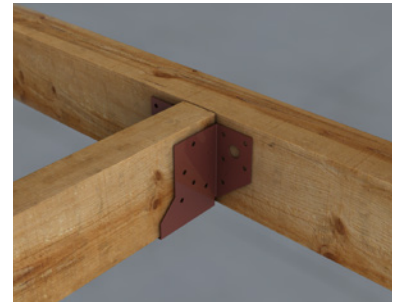

DC/L
'L' Bracket

Manufactured from 2.5mm thick galvanised steel, powder coated after fabrication for superior dual coated corrosion protection.

Code DC/L150
Box Qty. 50

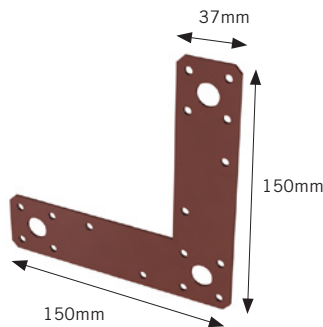

DC/T
'T' Bracket

Manufactured from 2.0mm thick galvanised steel, powder coated after fabrication for superior dual coated corrosion protection.

Code DC/T150
Box Qty. 50

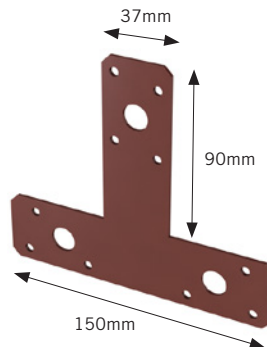

DC/MPC
Multi Purpose Connector

A multi purpose connector designed to be bent on site to suit many timber to timber jointing applications. Manufactured from 1.5mm galvanised steel, powder coated after fabrication for superior dual coated corrosion protection.

Code DC/MPC/40X40
Box Qty. 100

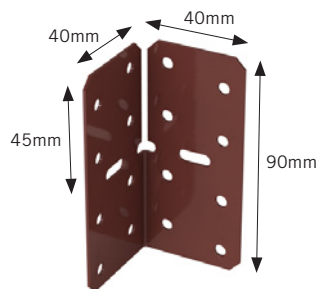

DC/WC
Wood Connector

A strong slotted bracket, manufactured from 3mm thick galvanised steel. Powder coated for superior dual coated corrosion protection.

Code DC/WC/85X40
Box Qty. 100



Miscellaneous Products

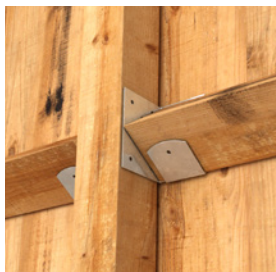

Also available in
RETAIL PACKS OF LH & RH

ARSB

Arris Rail Support Bracket (Handed)

Suitable for fixing arris rails to timber posts during new fence construction. Fixed to the post using screws and/or coach screw/bolt.

Code	Pack Qty.
ARSB/RH/50PK	50
ARSB/LH/50PK	50



Also available in
RETAIL PACKS OF 4

ZC

Z Clip

A galvanised clip used to fix fence or trellis panels to timber posts. An alternative to 'U' shaped clips, use 8 per fence panel.

Code	Pack Qty.
ZC/4PK	40 x 4 PK



Also available in
RETAIL PACKS OF 10

LRP

Long Roll Pin

A Sturdy galvanised steel pin, designed to be driven into soil to secure log border roll. Simply insert the pin into the soil and nail or screw through the pre-punched holes into the timber.

Code	Pack Qty.
LRP/450	50



Also available in
RETAIL PACKS OF 10

SEC

Panel Security Bracket

Designed to secure fence panels to 4" concrete posts. An economical, easy to fix bracket to help prevent unwanted removal or theft.

Code	Pack Qty.
SEC/10PK	5 x 10 PK

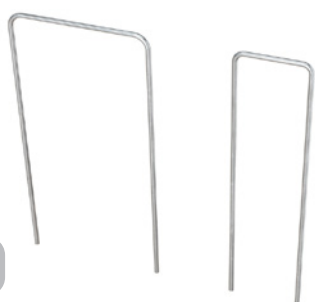

Also available in
RETAIL PACKS OF 50

PGS

PowaGuard™ Ground Staples

Galvanised steel ground staples used to secure weed/ground control fabric to the ground. Supplied in retail bags of 50 pieces.

Code	Pack Qty.
PGS/25/150/50PK	10 x 50 PK
PGS/100/150/50PK	10 x 50 PK

PowaRack™ Storage Solutions

PR

PowaRack™ Storage Solutions

PowaRack™ boltless shelving offers a strong versatile solution for storage in the home, office or workplace.



Manufactured from heavy gauge powder coated mild steel, PowaRack™ shelving simply slots together without the need for bolts or fixings. Shelves are manufactured from high density board for extra strength and durability.

Packed in an attractive retail display box, full assembly instructions are included with all products, together with floor protectors and top end caps.

Code	Shelves	Width	Depth	Height
PR2/45A	2	900mm	450mm	900mm
PR3/45B	3	900mm	450mm	900mm
PR5/45AB	5	900mm	450mm	1800mm



PowaRack™ Boltless Shelving

PowaRack™ shelving units are available in a range of sizes and are packed with flexibility in mind. Our 5 shelf unit is supplied in two retail display boxes, which can be purchased individually as a 2 shelf or 3 shelf option, or added together to make a 5 shelf unit. In addition to the full assembly instructions contained in the pack, build options are clearly displayed on all packaging.

This versatile, boltless shelving unit requires no nuts and bolts and can be assembled in minutes using only a hammer. Finished in a tough powder coating providing a smooth finish with no sharp edges.

- Speedy assembly using only a rubber mallet
- Adjustable shelf height
- Can be assembled as 3 different units
- 265kg UDL per shelf loading capacity
- High strength 9mm fibreboard shelves
- Available from stock for same day dispatch
- Superior informative display packaging



Also available in **RETAIL PACKS**

PowaPost® Cube

POWAPost

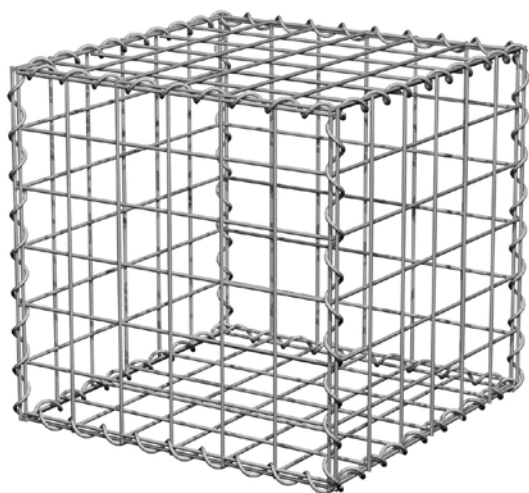

CUBE3030



CUBE3060



CUBE4545



CUBE4560

Also available in
RETAIL PACKS

CUBE

PowaPost® Cube

A galvanised landscaping wire gabion manufactured from 3mm diameter 50x50mm mesh, hot dipped galvanised for superior durability and corrosion protection.

Use PowaPost® Cube indoors and out to create:

- Terracing & Landscaping
- Ponds & Water Features
- Raised Beds & Walling
- Garden & Patio Seating
- Tables & Benches

The PowaPost® Cube is a quick and easy to use building block suitable for many garden landscaping applications which is also ideal for creating stylish features both indoors and out.

Be Creative

The PowaPost® Cube should be filled with decorative rocks or cobble for landscaping but for more creative and artistic applications why not use logs, plastic bottles, glass jars or painted rocks.

Available in four standard sizes, packed 1 cube per inner pack, including all fixings and assembly instructions.

Code	Timber Size	Pack Qty.
CUBE/3030	300 x 300 x 300mm	1
CUBE/3060	300 x 300 x 600mm	1
CUBE/4545	450 x 450 x 450mm	1
CUBE/4560	450 x 450 x 600mm	1

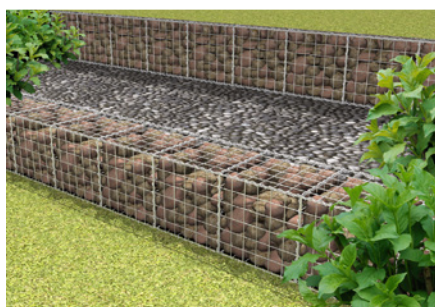
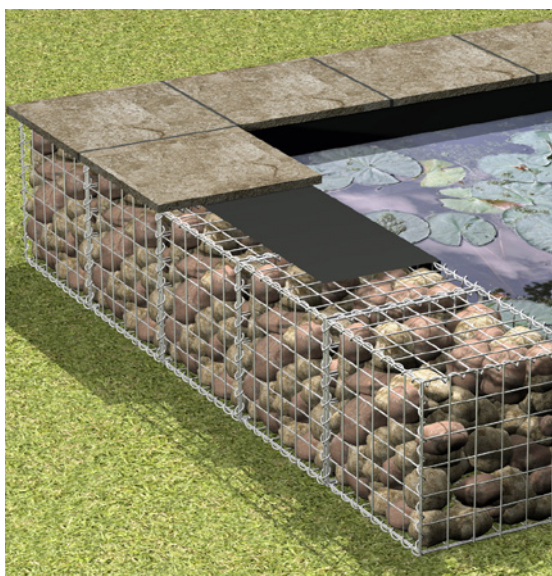

PowaPost® Gates

GATE/AVON

PowaPost® Avon Gate

Nothing sets off a home like a brand new gate in a tough, elegant black finish. PowaPost® Avon gates are simple to install (we even include all hinge and latch fixings – also available as a separate pack) and are Phosphate Treated and fully finished in Powder Coated Black Gloss.

Suitable for a 900mm opening.

The gate dimensions are
838mm wide x 910mm high.

Also available in
RETAIL PACKS

To fit larger openings, simply install black painted wooden sections to one or both sides of the gate.

Simple to Install

- Hinge and Latch Fittings included
- Sturdy Welded Steel Construction
- Phosphate Treated and Powder Coated Black Gloss
- Looks Good - Whatever the Season
- Can be fitted as Left or Right Hand Opening
- Supplied in large retail pack ready for shipment.



GATE/SURREY

PowaPost® Surrey Gate

Nothing sets off a home like a brand new gate in a tough, elegant black finish. PowaPost® Surrey gates are simple to install (we even include all hinge and latch fixings – also available as a separate pack) and are Phosphate Treated and fully finished in Powder Coated Black Gloss.

Suitable for a 900mm opening.

The gate dimensions are
838mm wide x 1090mm high.

Also available in
RETAIL PACKS

To fit larger openings, simply install black painted wooden sections to one or both sides of the gate.

Simple to Install

- Hinge and Latch Fittings included
- Sturdy Welded Steel Construction
- Phosphate Treated and Powder Coated Black Gloss
- Looks Good - Whatever the Season
- Can be fitted as Left or Right Hand Opening
- Supplied in large retail pack ready for shipment.

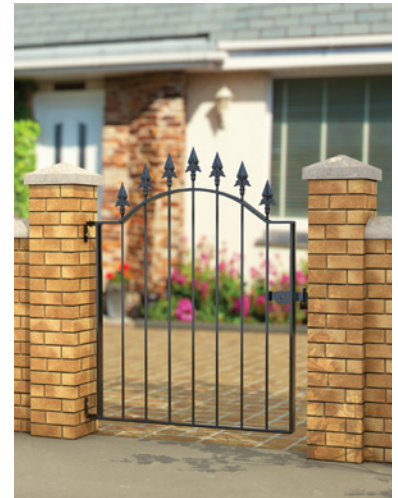

GATE/HAMBLE

PowaPost® Hamble Gate

Nothing sets off a home like a brand new gate in a tough, elegant black finish. PowaPost® Hamble gates are simple to install (we even include all hinge and latch fixings – also available as a separate pack) and are Phosphate Treated and fully finished in Powder Coated Black Gloss.

Suitable for a 900mm opening.

The gate dimensions are
838mm wide x 1030mm high.

Also available in
RETAIL PACKS

To fit larger openings, simply install black painted wooden sections to one or both sides of the gate.

Simple to Install

- Hinge and Latch Fittings included
- Sturdy Welded Steel Construction
- Phosphate Treated and Powder Coated Black Gloss
- Looks Good - Whatever the Season
- Can be fitted as Left or Right Hand Opening
- Supplied in large retail pack ready for shipment.



Available from:

All illustrations, technical information, descriptions, British and European Standards contained within this publication are intended for guidance only and shall not constitute a "sale by description". All information is provided correct at time of printing (September 2020). The Company pursues a policy of constant product development and information contained in this publication is therefore subject to change without notice. All dimensions given are nominal. Updates will not be issued automatically. The information is not intended to have any legal effect, whether by way of advice, representation or warranty (express or implied). We accept no liability whatsoever (to the extent permitted by law) if you place any reliance on this Publication you must do so at your own risk.

Please contact the Head Office should you have any technical enquiries. ©BPC Building Products Ltd 2020.

BPC Building Products Ltd.

Flanshaw Way
Wakefield
WF2 9LP

Tel: +44 (0)1924 364794

Fax: +44 (0)1924 373846

web: www.bpcfixings.com

email: sales@bpcfixings.com

Head Office

Vista Engineering Limited
Carr Brook Works
Elnor Lane
Whaley Bridge
High Peak SK23 7JN

Tel: Sales: +44 (0) 1663 736700

Fax: +44 (0) 1663 733232

web: www.vistaeng.co.uk

email: sales@vistaeng.co.uk

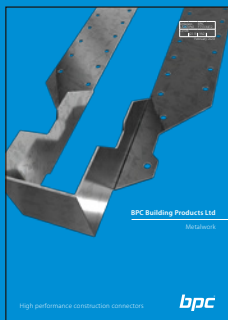

Contact us to enquire about our other product ranges or request a catalogue.

